

Szafka RTV | TV cabinet | TV Lowboard | Armoire TV

VELDIO

175

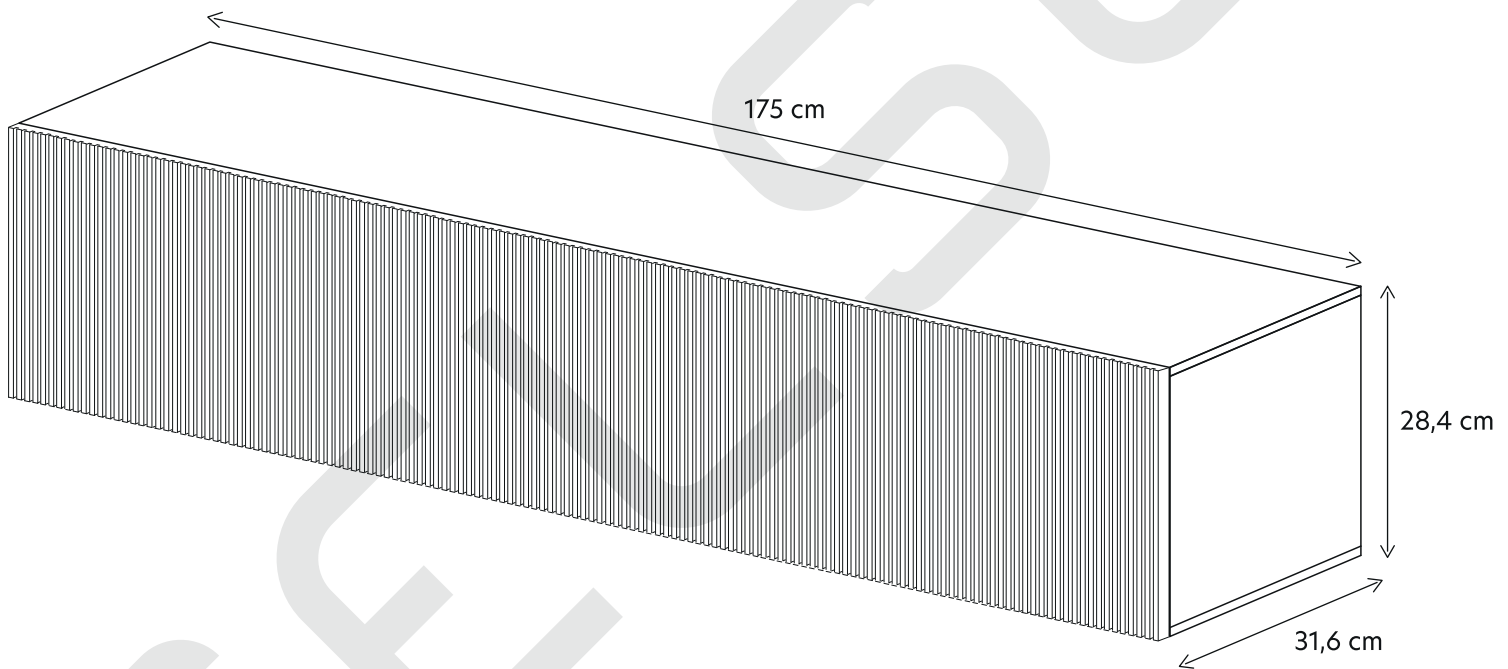

- ! - Zalecamy nie wyrzucać opakowania dopóki nie ukończysz montażu.
- - Montażu najlepiej dokonać na miękkiej i czystej powierzchni, takiej jak tekstura, ręcznik, koc.
- - Uchroni to przed uszkodzeniem krawędzi mebla.
- - Zarówno opakowania plastikowe, jak i okucia trzymać w miejscu niedostępnym dla niemowląt i dzieci.
- - Wszystkie połączenia powinny być odpowiednio dokręcone.
- - Przed przystąpieniem do montażu prosimy zapoznać się z całą instrukcją montażu.
- - Nie montować elementów jeśli zauważysz wady lub uszkodzenia.

- ! - Wir bitten Sie, die Verpackung so lange aufzubewahren, bis Sie das Möbel vollständig aufgebaut haben.
- - Führen Sie die Montage am besten auf einem weichen und sauberen Untergrund, wie z.B. einem Teppich oder einer Decke durch, um Kratzer oder andere Beschädigungen zu verhindern.
- - Halten Sie bitte Plastikverpackungen und Werkzeuge von Babys, Kindern und Kleinkindern fern.
- - Schrauben Sie bitte alle Verbindungen entsprechend fest.
- - Lesen Sie bitte die gesamte Anleitung vor dem Aufbau des Möbels aufmerksam durch.
- - Montieren Sie bitte keine fehlerhaften oder beschädigten Elemente.

- ! - We recommend that you do not discard the packaging until you complete the assembly.
- - We recommend assembling on a soft clean surface (eg. towel, blanket, carpet) so as to avoid damaging the edges of the furniture.
- - Both plastic packaging and fittings should be kept out of reach of infants and children.
- - All screws should be properly tightened.
- - Before assembly, please read the entire assembly manual.
- - Do not assemble the furniture if you notice any defects or damage to the components.

- ! - Nous vous recommandons de ne pas jeter l'emballage avant d'avoir terminé le montage du meuble.
- - Nous vous recommandons de monter le meuble sur une surface douce et propre comme le carton, la serviette ou la couverture. Cette solution vous permettra d'éviter les dommages du meuble.
- - Veuillez protéger les pièces en plastique, les patins en feutre et les glissades s'il vous plaît contre les enfants.
- - Toutes les connexions du meuble doivent être bien montées.
- - Avant le montage, merci de lire toute la notice du montage s'il vous plaît.
- - Notez bien : veuillez ne pas monter le meuble s'il vous plaît si vous voyez soit des défauts soit des dommages au meuble ou du colis.

! Przed przystąpieniem do montażu prosimy sprawdzić czy nie brakuje żadnych elementów.

• Before the assembly, please check if there are no missing parts.

Überprüfen Sie bitte vor dem Aufbau die Vollständigkeit der Bauelemente.

Avant le montage du meuble, merci de vérifier si le colis est complet.

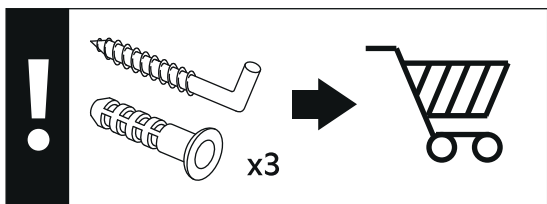
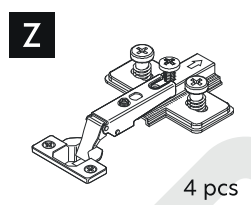
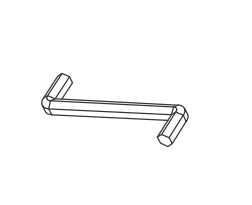
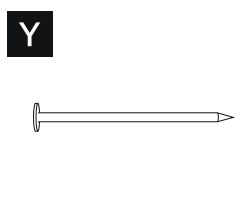
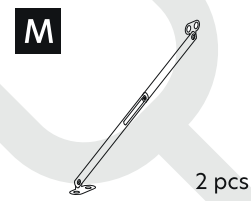
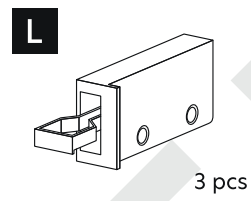
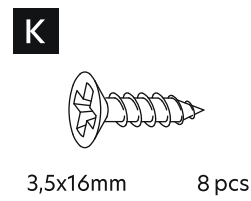
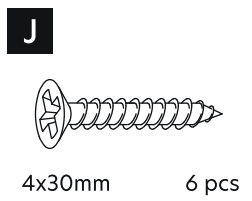
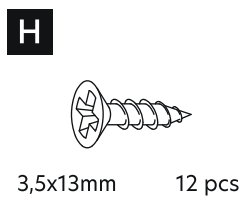
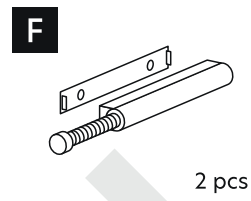
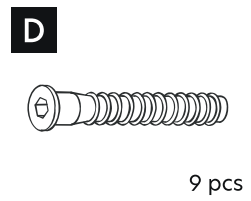
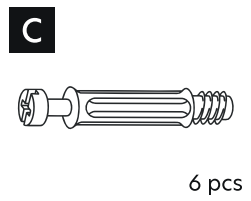
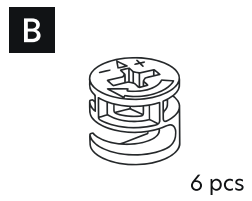
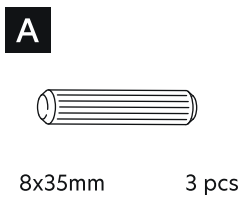

Do montażu mebla nie należy używać wkrętarki.

Do not use a screwdriver to assemble the furniture.

Verwenden Sie keinen Schraubendreher, um die Möbel zusammenzubauen.

N'utilisez pas de tournevis pour assembler le meuble.

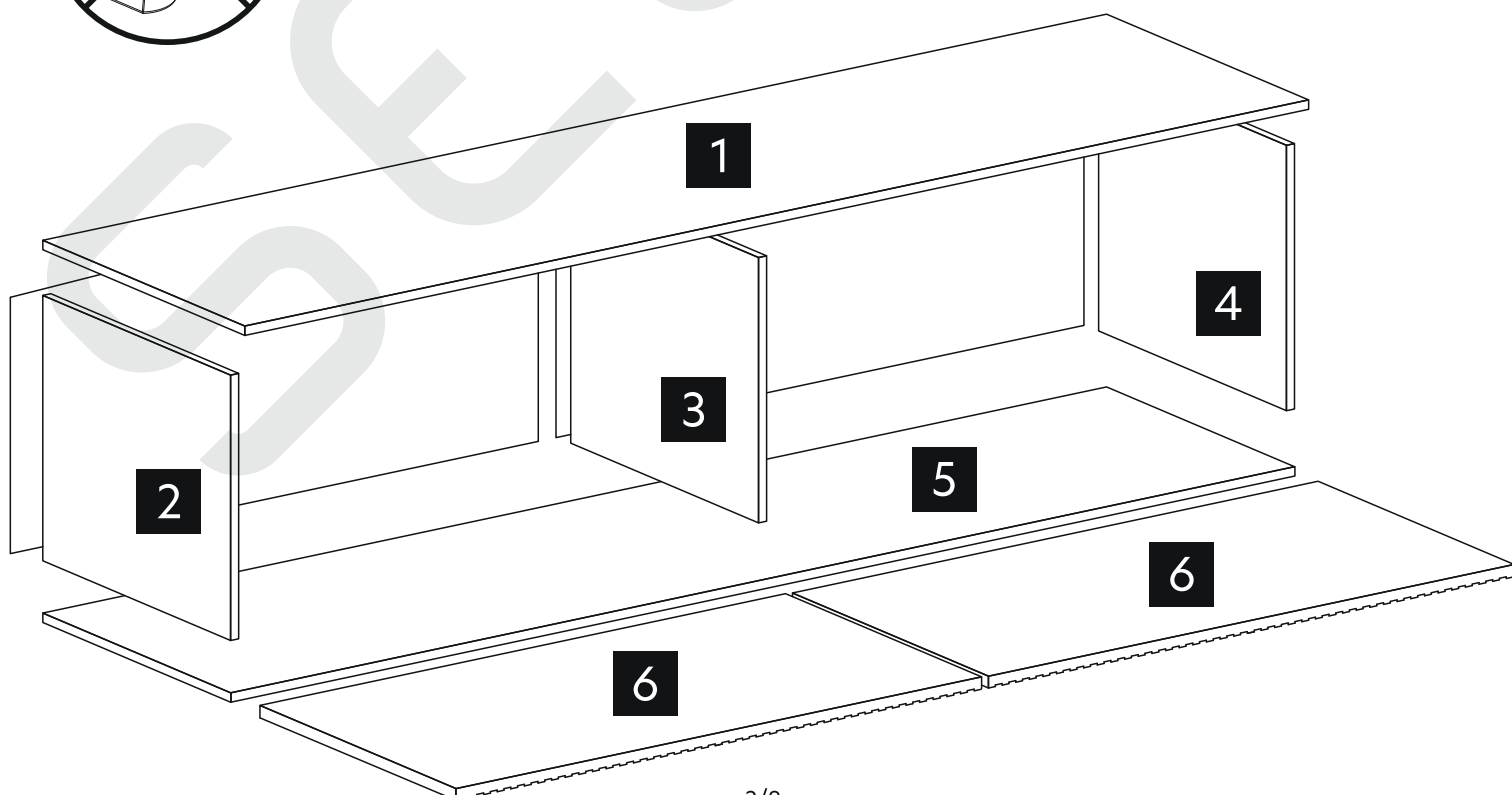

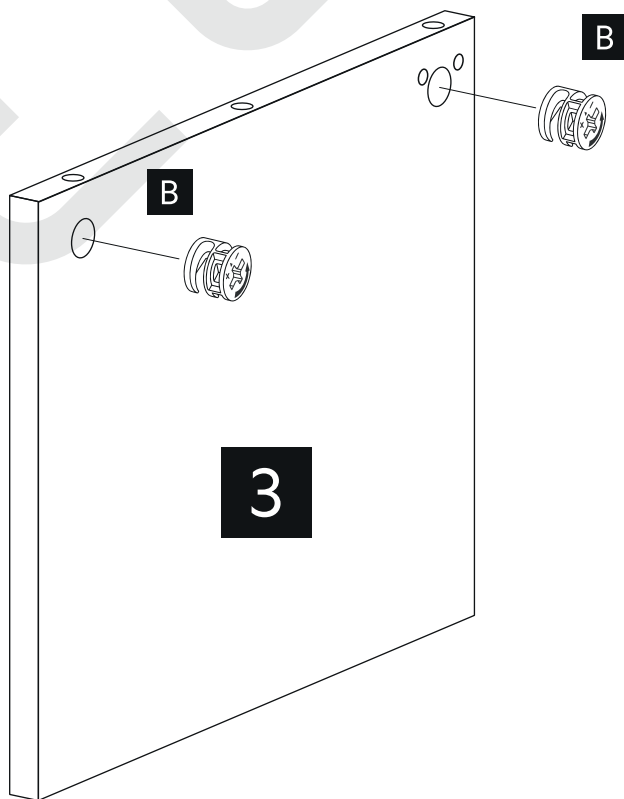
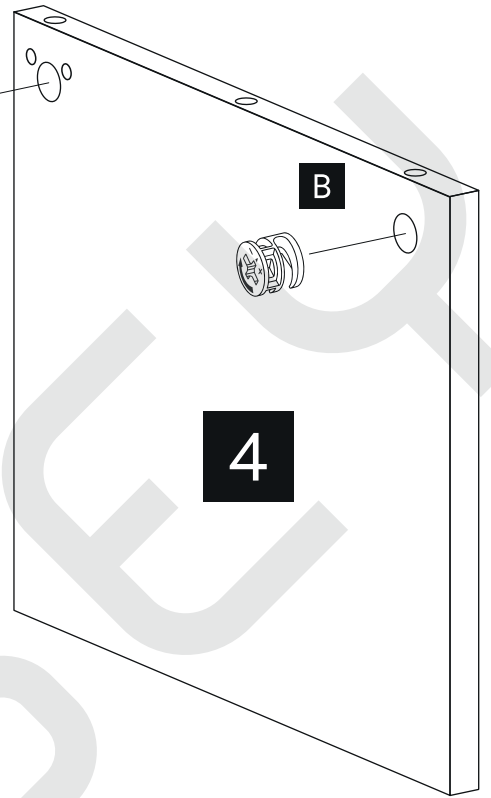
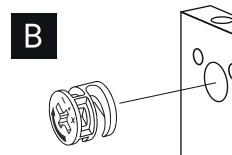
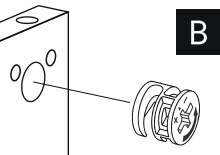
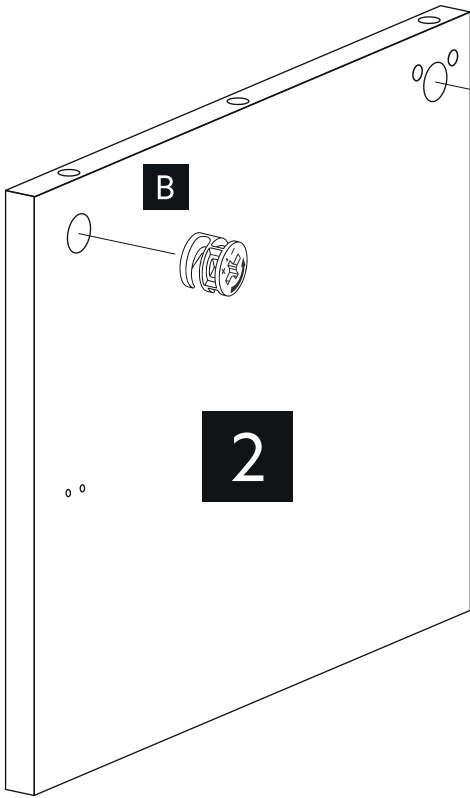
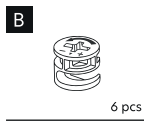

Z

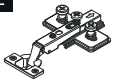

4 pcs

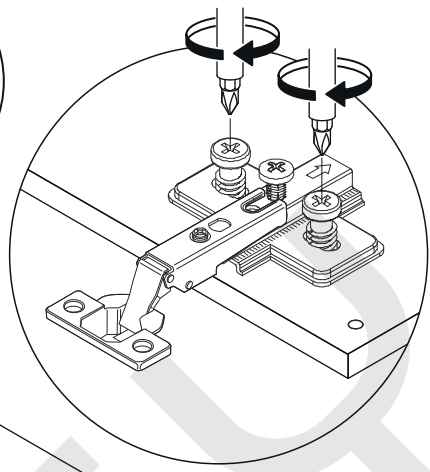

5

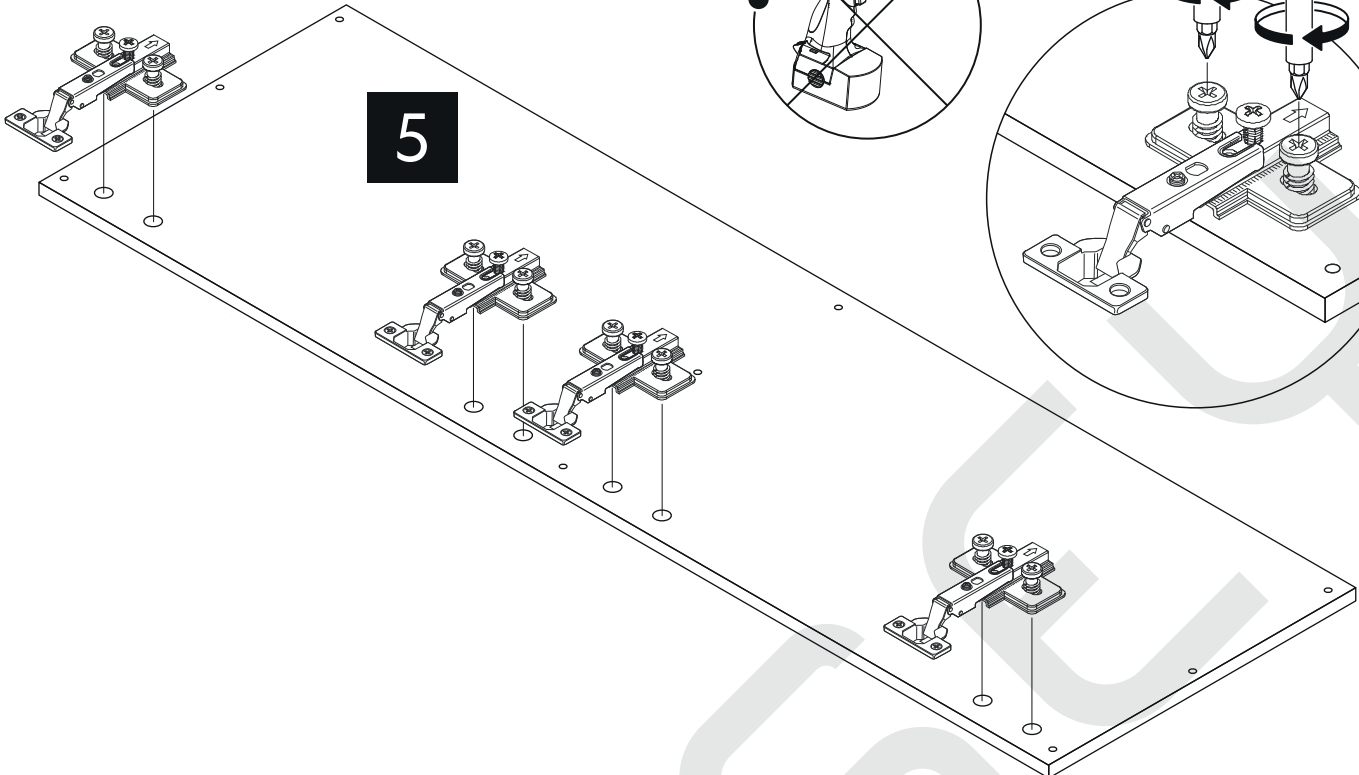

D



6 pcs

