

# NEL 1-2 BU

PRODUCTION DATE	PACKING CODE

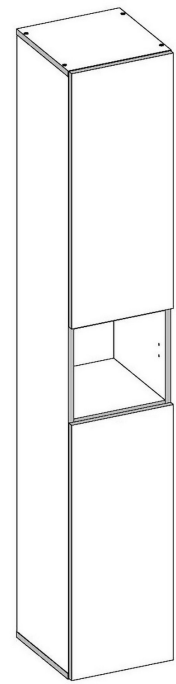

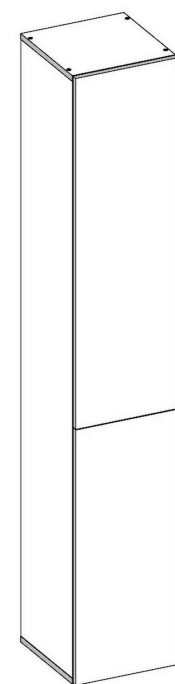





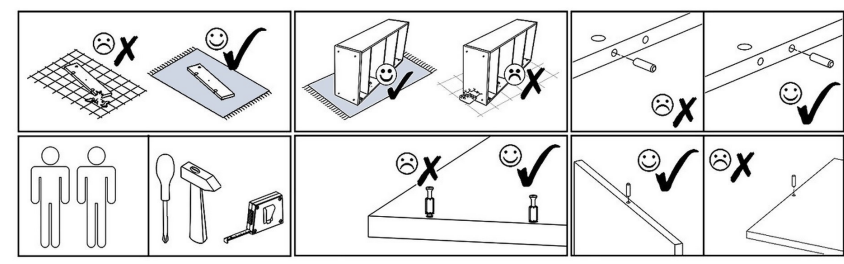







NEL 1 BU



NEL 2 BU





<b>V23</b>  5,5x10,5mm x4	<b>T1</b>  x4	<b>V35</b>  x2	<b>V16</b>  5x16mm x8	<b>V13</b>  x1	<b>B3</b>  ø7-8/5mm x4	<b>B3</b>  ø7-8/5mm x4	
<b>Z1</b>  x80	<b>F1</b>  7x50mm x8	<b>F3</b>  Hex 4mm x1	<b>M1</b>  12x15mm x8	<b>N1</b>  L=35mm x8	<b>A1</b>  ZP x4	<b>S1</b>  3,5x16mm x12	<b>E1</b>  8x30mm x8

# NEL 1-2 BU

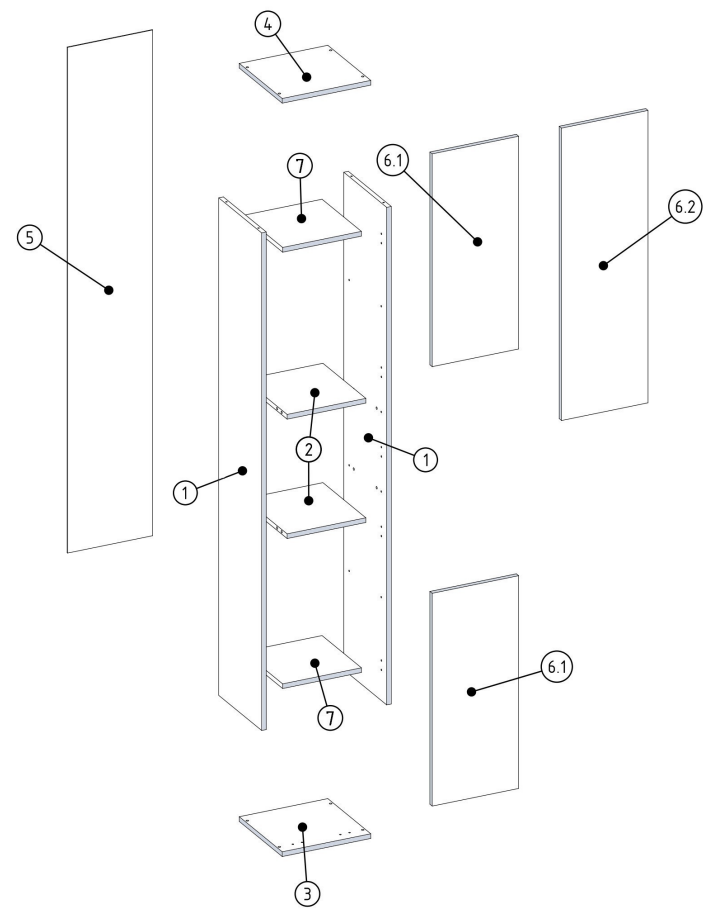



PRODUCTION DATE	PACKING CODE



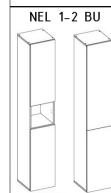
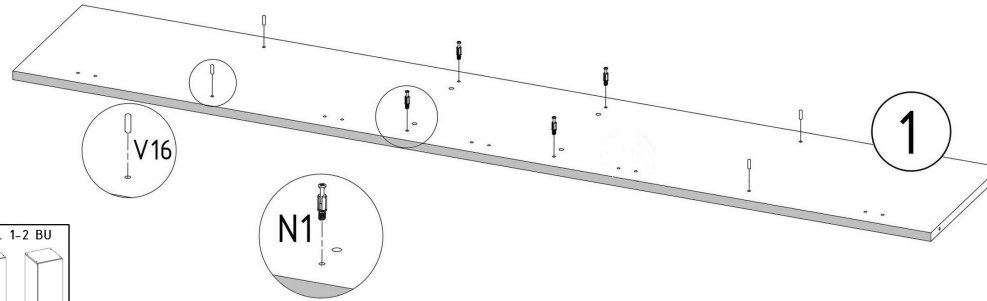
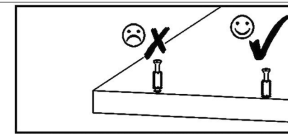

000022	7	2
000234	6.2	1
000166	6.1	2
000262	5	1
000037	4	1
000036	3	1
000023	2	2
000260	1	2
ID	NUMBER	QUANTITY

<b>N1</b>  L=35mm X4	<b>V16</b>  5x16mm X4
--	---

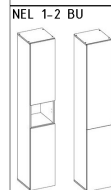
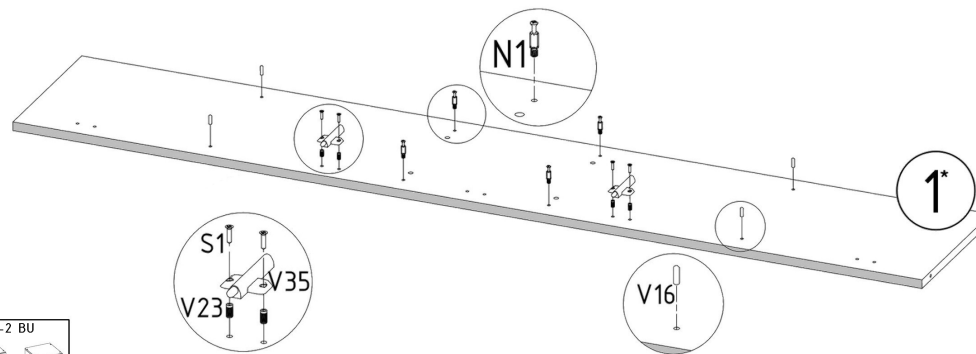
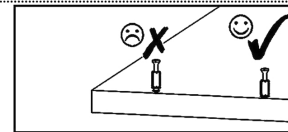

<b>N1</b>  L=35mm X4	<b>V16</b>  5x16mm X4	<b>V23</b>  5,5x10,5mm X4	<b>V35</b>  X2	<b>S1</b>  3,5x16mm X4
---	--	--	--	---



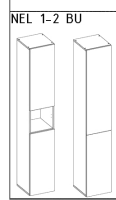
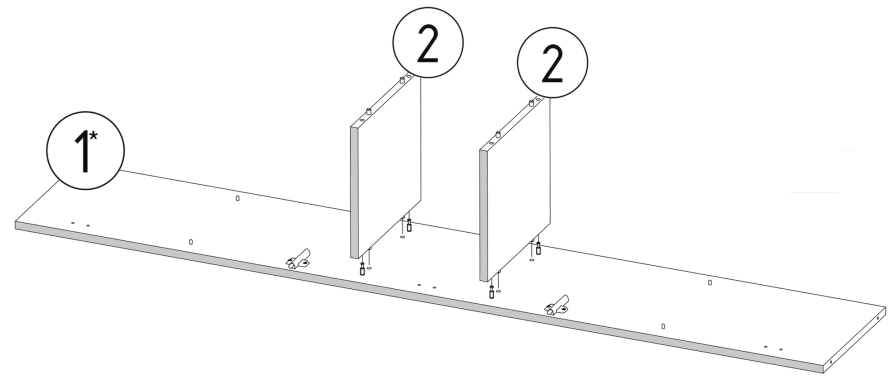
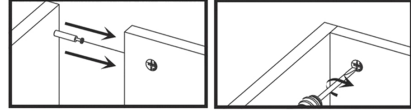
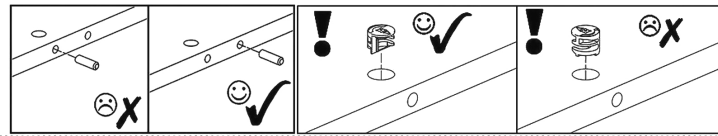
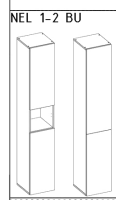
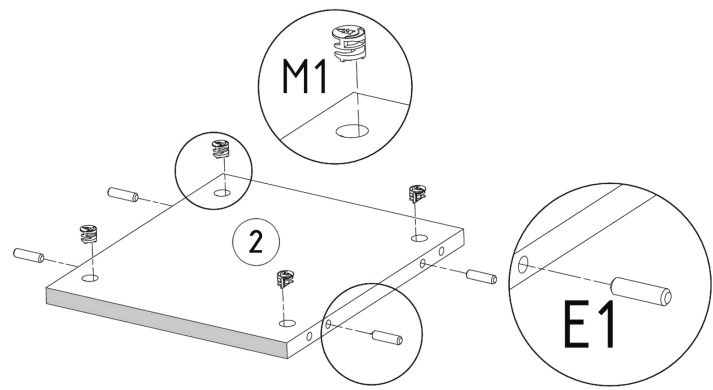

<p><b>M1</b></p> 	<p><b>E1</b></p> 
<p>12x15mm</p>	<p>x8 8x30mm x8</p>

x2

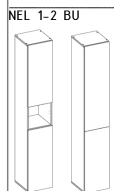
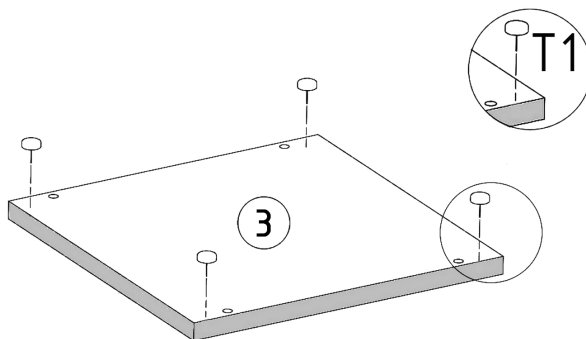
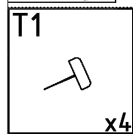
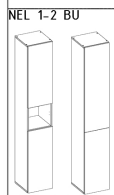
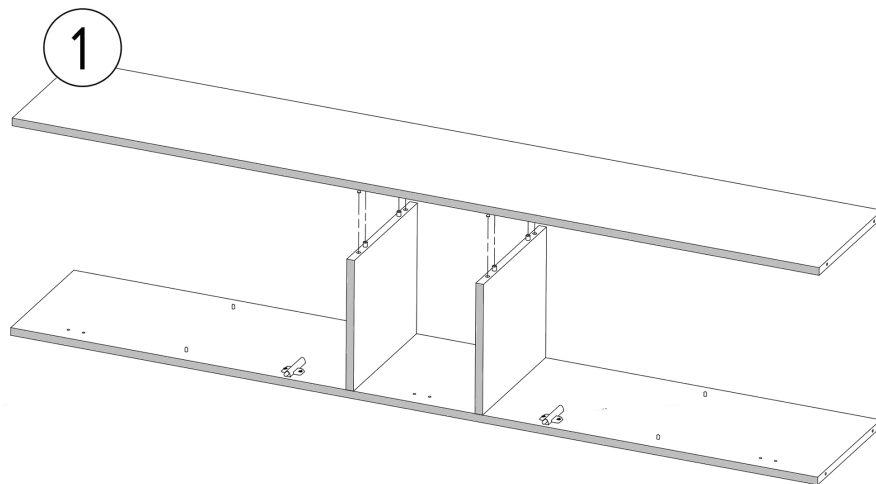
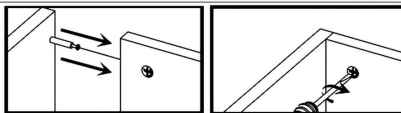

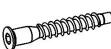

<b>F1</b>  7x50mm	<b>F3</b>  Hex 4mm
---	--

x8 x1

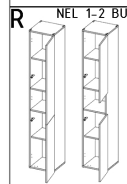
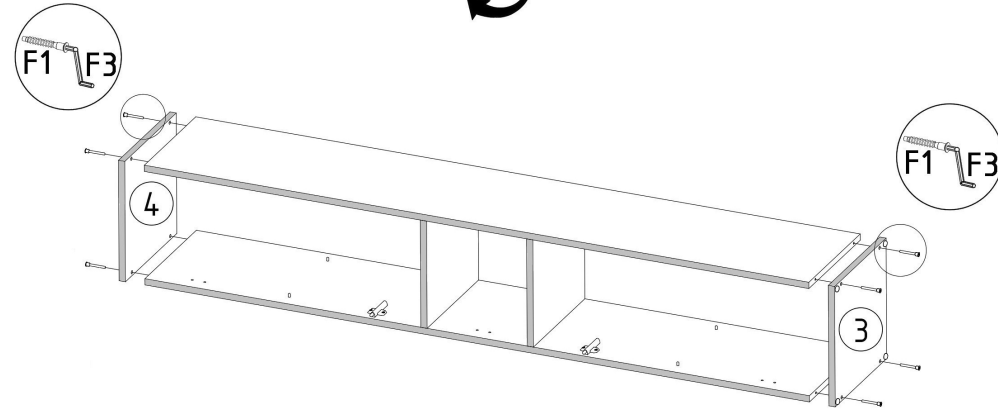
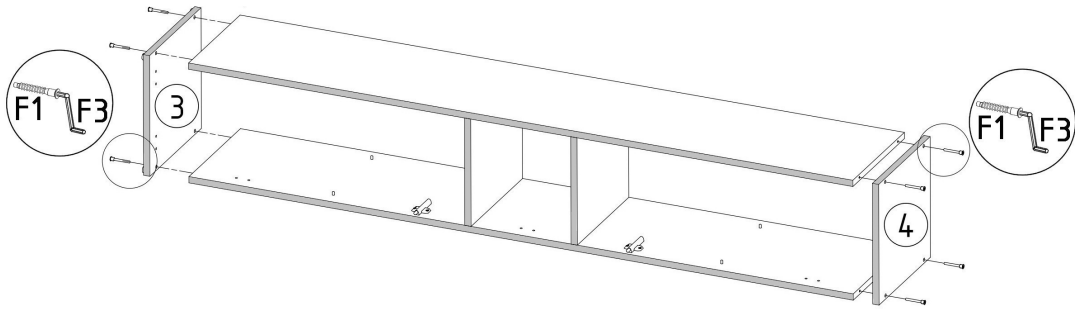
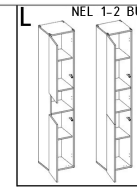

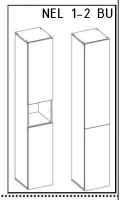
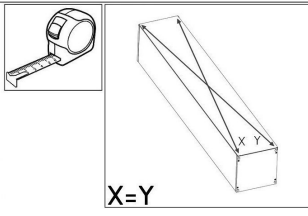
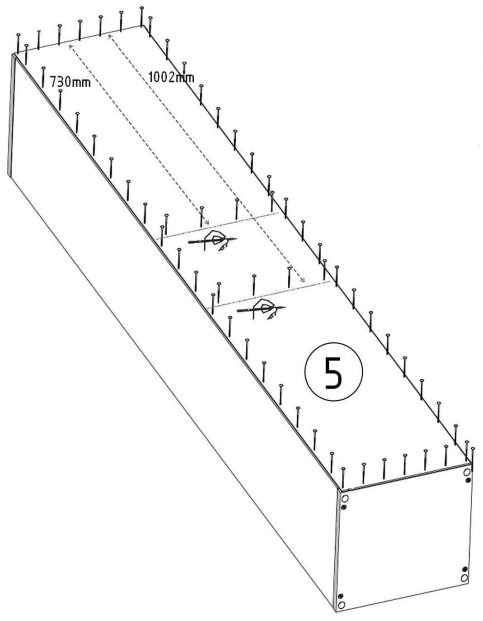
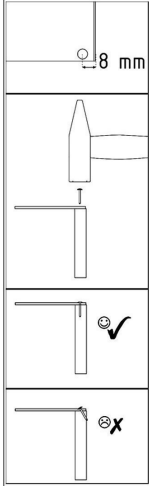

Z1  
x80



A1  
ZP x4

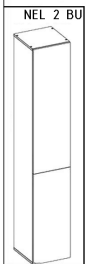
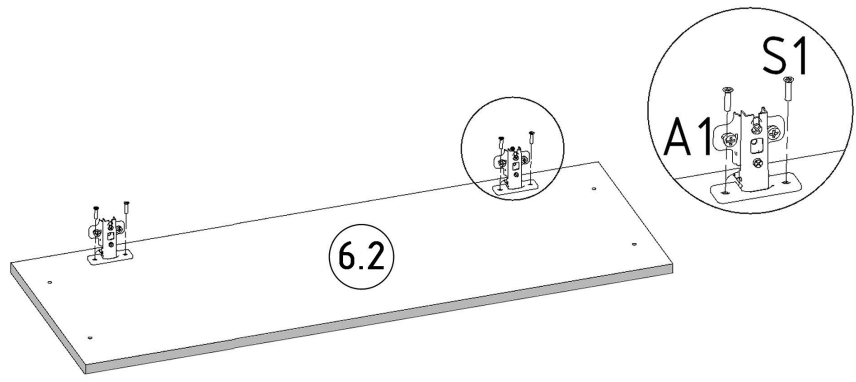
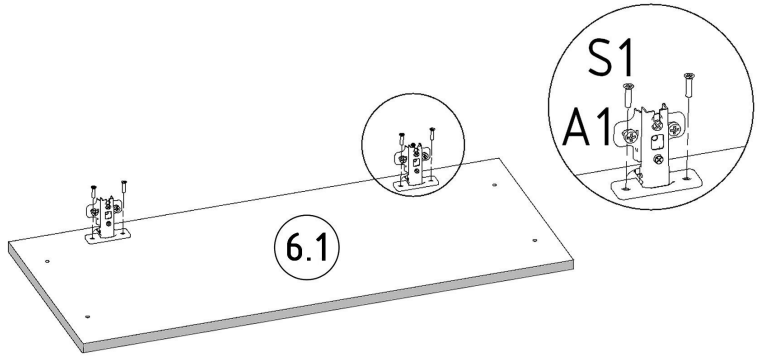

S1  
3,5x16mm x8

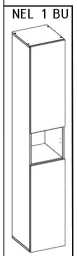
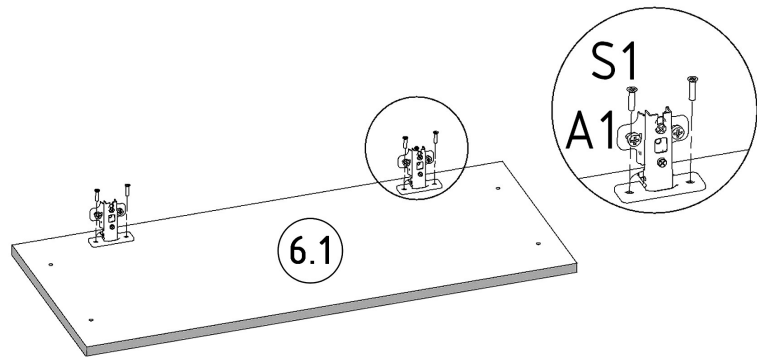

<p><b>A1</b></p> 	<p><b>S1</b></p> 
<p>ZP x4 3,5x16mm x8</p>	



x2

<p><b>V13</b></p> 	<p><b>B3</b></p> 
<p>x1 ø7-8/5mm x4</p>	

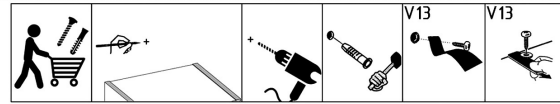

NEL 1 BU

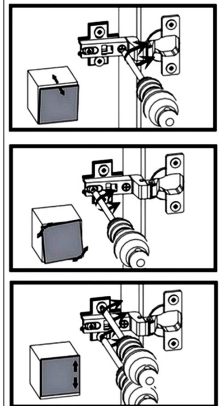
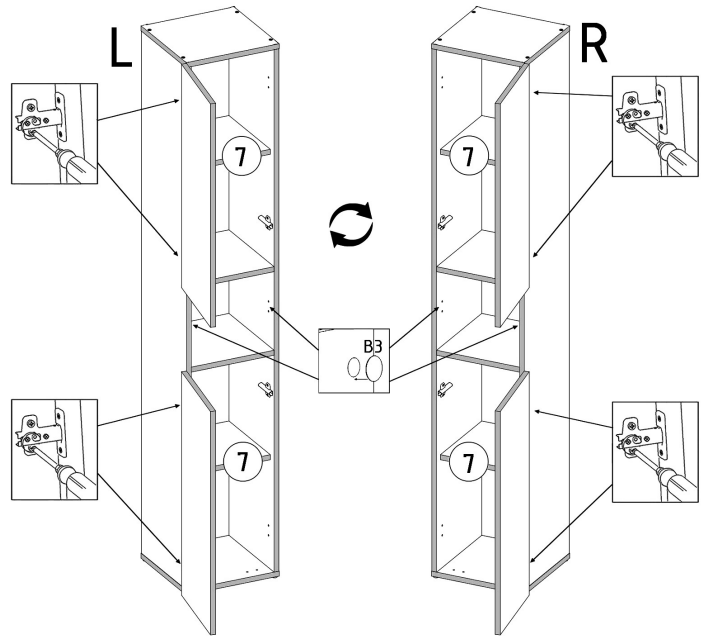



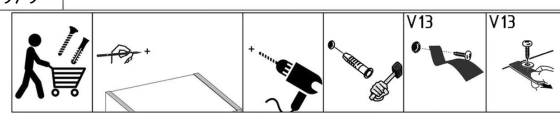

NEL 2 BU

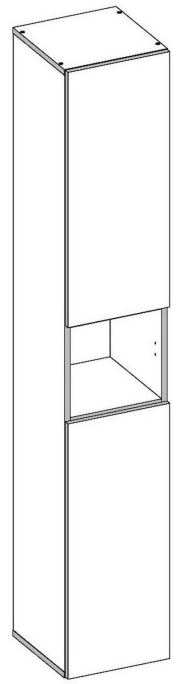
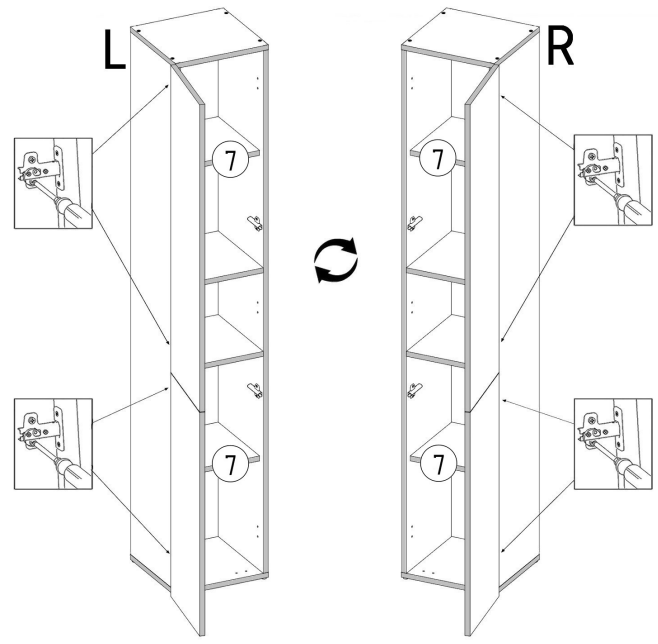
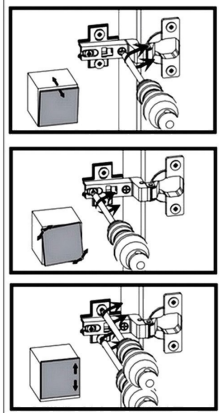

NEL 1 BU

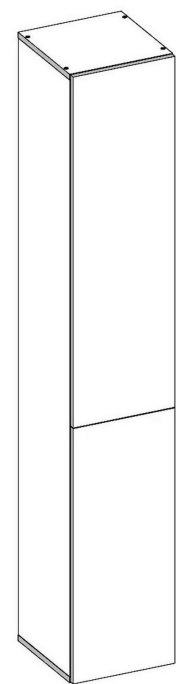

NEL 2 BU