

# NAROŽNIK

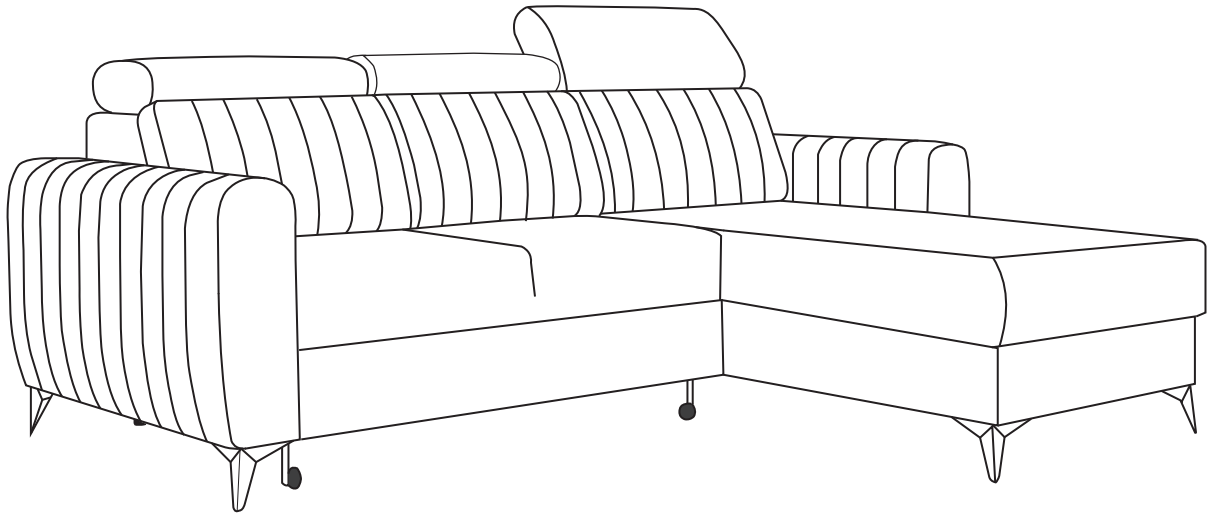

CR

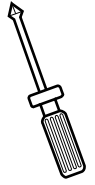
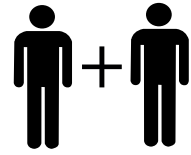
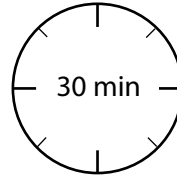
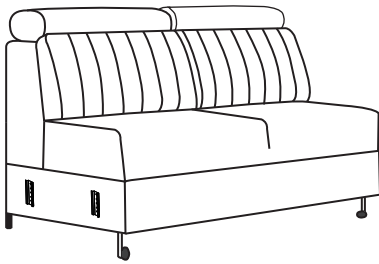

X1

O

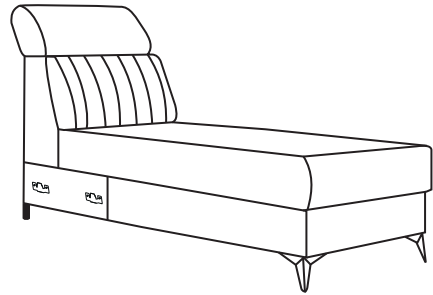

X1

B

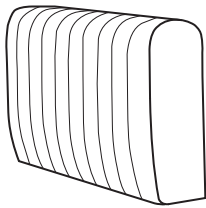

X2

W 5x40

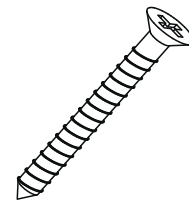

X24

N1

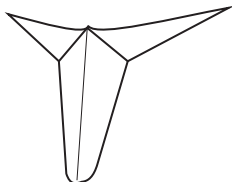

X6

N2



X4

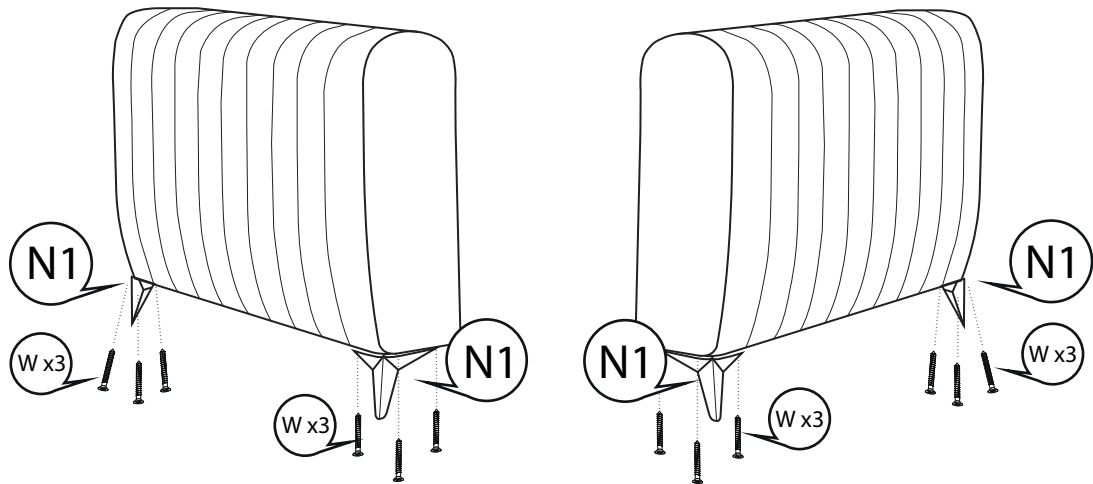
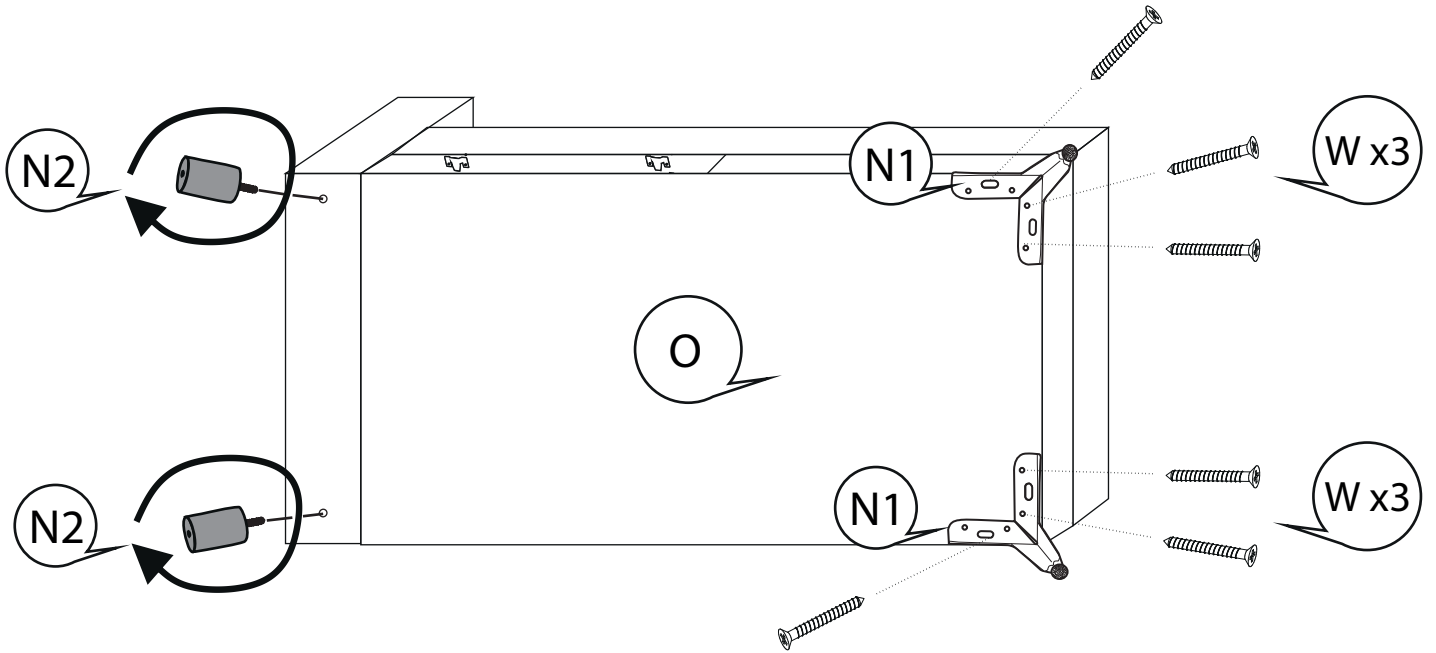
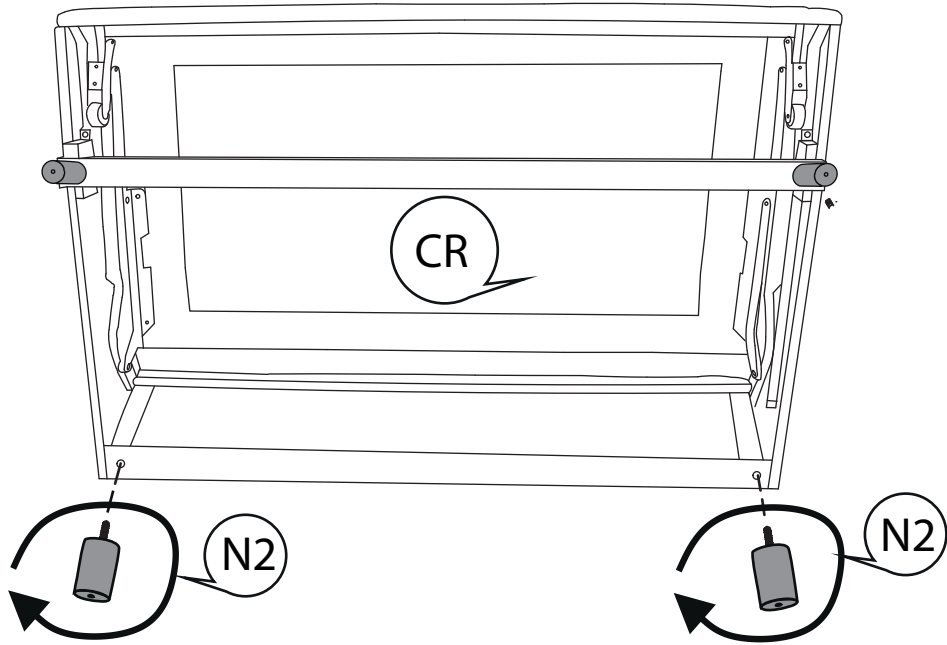

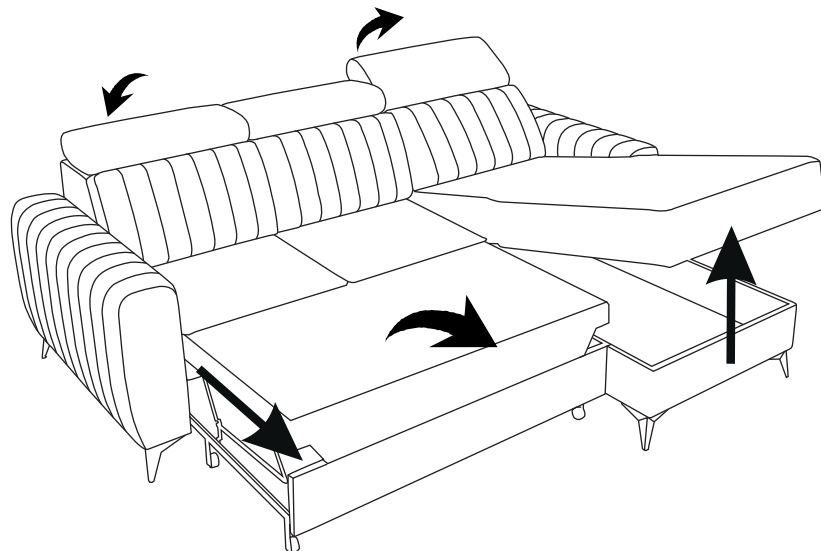
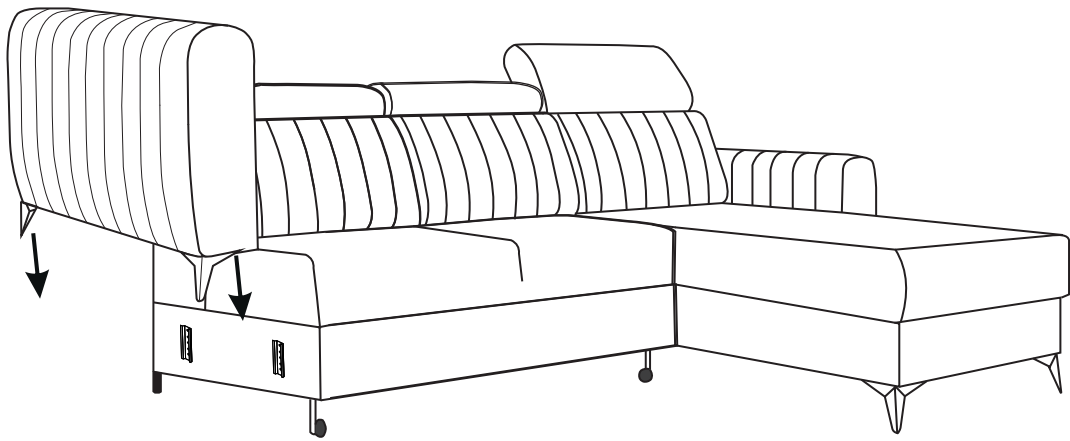
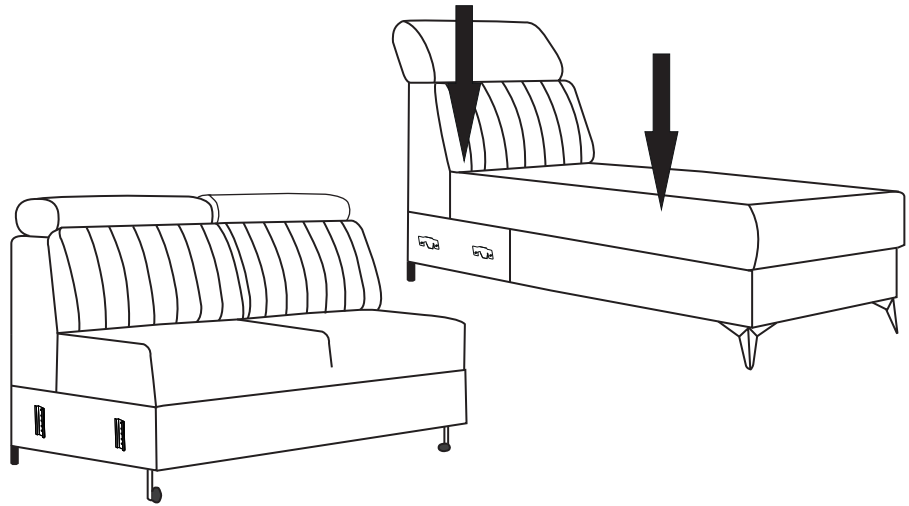
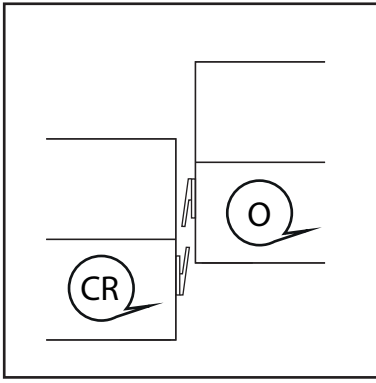

# ZMIANA STRONY / CHANGING THE SIDE OF THE CORNER

